

NEW RANGE

EVOJTA 3

MODE

DAB  
EVOJTA

SIMPLY  
RELIABLE



**DAB**  
WATER • TECHNOLOGY

## DAB. Innovation is not a goal but a new starting point.

This is not just a presentation of the new range of Evosta electronic circulators. It is much more.

It is a story that began 43 years ago, **about a path of technological innovation** and about the application of a new way of imagining, creating, producing and working at DAB.

The result is the new Evosta range of circulators, **the perfect synthesis between the strength of the mechanical circulator and the benefits of the electronic.**

Find it out with us.

### DAB 4.0

DAB inaugurates the new Factory 4.0 with the new **Evosta** circulators.

A robotised production line where man, technology and services are integrated in the name of human safety and top quality of the product.

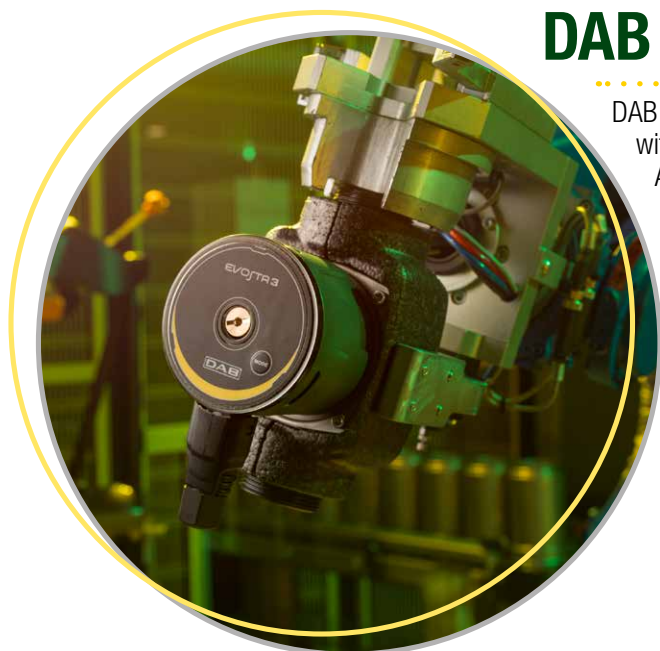

### A future of innovation

Replacing the previous Evotron and Evosta and on the basis of the success of **over 20 million pieces sold**, the new range points to the future with the boost of an unprecedented technological acceleration.





## Performance and efficiency

Innovation, quality, performance and reliability all play a part in improving the performance and efficiency of the product.



## DAB 4.0

### RELIABILITY 4.0

Smart factory, Brilliant factory, Factory 4.0, Industry 4.0, Industrial Internet.

**Innovation is about capacity, not words.** It is about having a vision and adopting it in the corporate culture and complex organisational system.

DAB has done precisely this with the new range of Evosta electronic circulators. It is the first of its kind to be designed and produced using an entirely Smart process.

### TECHNOLOGIES 4.0

New technologies integrate the processes of operators, machines and tools.

### SERVICES 4.0

IT and technical infrastructures connect systems and people in a collaborative way to improve safety and the quality of work.

### SUSTAINABILITY 4.0

Ongoing research in energy efficiency represents a social duty for DAB.

Optimising resources and using them in a sustainable and intelligent way can assist us in our digital transformation.

DAB's Factory 4.0 is the result of the collaboration and integration of Research and Development, Industrialisation and Procurement.

The process is, therefore, entirely stable and constant while ensuring maximum flexibility of production. All the phases of assembly of the new Evosta range are automated and involve intelligent **POKA-YOKE** control systems to guarantee fault-free production and a completely safe line for operators.





## **POKA-YOKE**

Poka-yoke is an industrial standard applied to a design choice or a device preventing any human error.

The concept is to avoid (yokeru) errors due to distraction and thereby ensure fault-free production and a risk-free workplace.

## RANGE

# A new range for the market of tomorrow

43 years of experience. over 20 million circulators sold.

History and know-how, together with the in-house design of the mechanics and electronics and the new DAB 4.0 factory, make the new Evosta electronic wet rotor circulators utterly innovative in terms of technology, reliability and performance.



## IPX5 TESTING

The infiltration of moisture in the mechanics and, most importantly, in the electronics of our products is no longer an issue.

The IPX5 degree of protection is tested by firing a water jet from a 6.3 mm nozzle on weak spots and openings with no infiltration into the device.

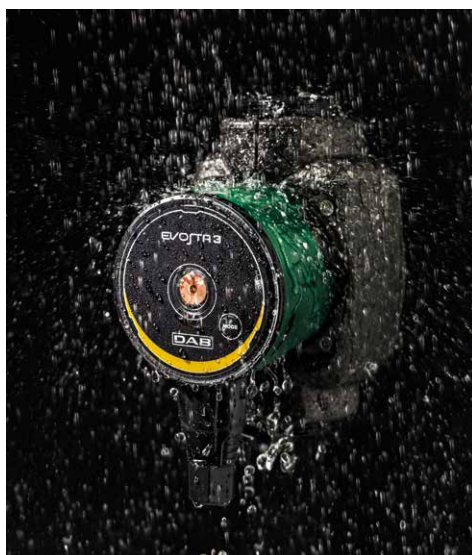

## IPX5

The waterproof electronics reduce faults to a minimum and ensure complete peace of mind.



## SELECTION GUIDE

	EVOSTA 3	EVOSTA 2
Display	•	
Quick connection plug	•	
Proportional differential pressure regulation mode	•	•
Constant differential pressure regulation mode	•	•
Fixed speed regulation mode	•	•
Dry run protection	•	
Auto-venting	•	
Airvent plug	•	•
Auto-unlock	•	•

# EVOSTA 3

## THE FIRST SMART CIRCULATOR

## FOR LIVING WITH COMFORT... AND NOT ONLY



Regular feedback from installers. All-round vision of technological and productive innovation. The new Evosta 3 electronic wet rotor circulator is based on this, on solid experience and an eye for the future. DAB's first own Smart circulator, the Evosta3, offers unique features thanks to the new DAB 4.0 factory which represents a great leap forward in terms of assisting the installer and improving the performance of the systems.

Compact size, quality of construction, innovative materials and technical solutions all make Evosta 3 high performing, reliable and easy to install at the same time. Thanks to its usability and efficiency, Evosta 3 is the ideal solution for domestic cooling or heating systems.



Q max  
4,2 m<sup>3</sup>/h

H max  
8 m

EEI ≤ 0.19

### WHY CHOOSE EVOSTA 3

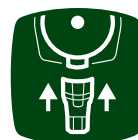
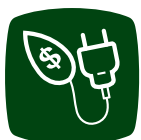

### APPLICATION





# Reliability, durability and practicality

## IPX5 PROTECTION

This certified degree of protection prevents the infiltration of water in the mechanics and, most importantly, in the electronics: faults are reduced to a minimum for absolute peace of mind.



## AIRVENT PLUG

Designed with front electronics and airvent plug providing access to the shaft in case of seizure.  
Evosta 3: easier maintenance for greater peace of mind

## STEEL MOTOR CASING

Made with stainless steel grade AISI 304 ensuring maximum comfort and long life, even in the case of cooling applications.



# EVOSTA 3

WHEN TECHNOLOGY

LEND US A HAND

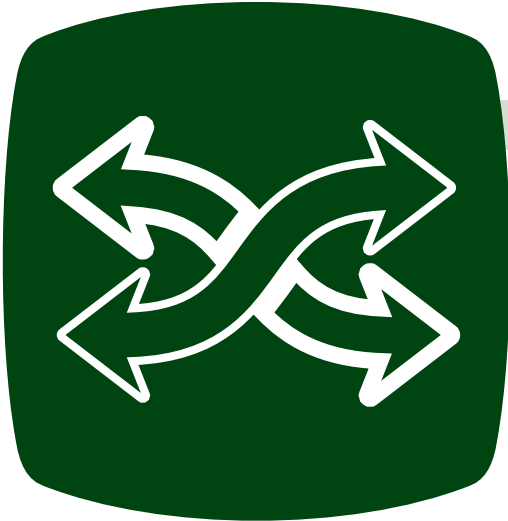

## EASY TO REPLACE

The circulator can now be replaced easily: the new interchangeable power connector of the Evosta 3 range can be used with connection plugs of other competitors without the need to rewiring all the electrical connections. Even the most awkward replacement is now quick and easy.

## ERGONOMIC INNOVATION

Dab's technological evolution has made possible a consistent reduction of the overall size of Evosta 3 now offering unparalleled flexibility.

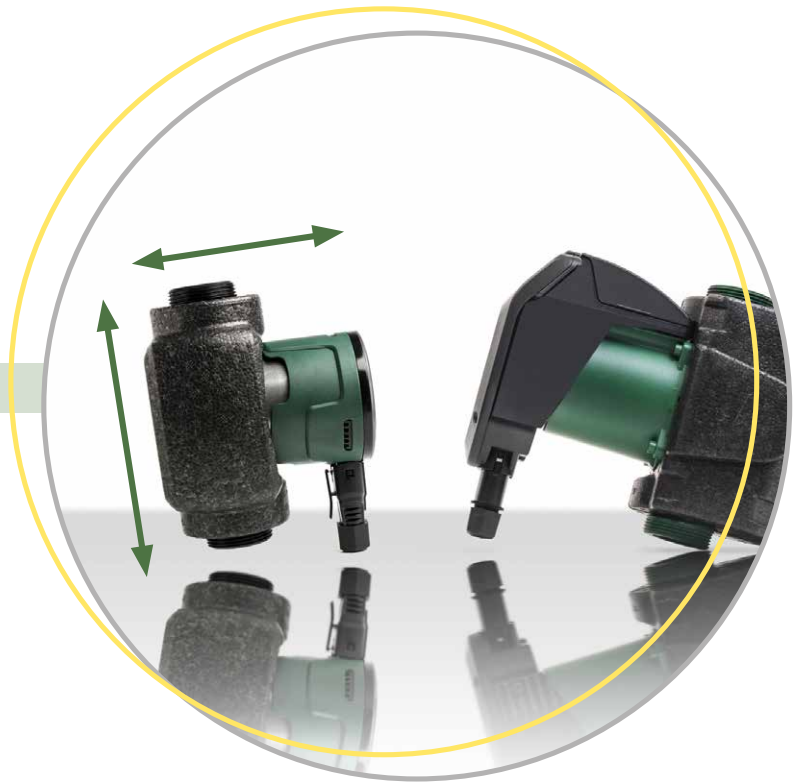

## WHEN SMART MEANS EASY

The new user interface with illuminated display and sequential button with immediate feedback makes easier the setting and readability under all conditions, since the settings remain available and can be edited at any time... with just a finger.



## MAXIMUM PERFORMANCE, MINIMUM CONSUMPTION

The energy performance of the new Evosta 3 has been improved with the new concepts of Smart energy and the use of an inverter, bringing the EEI index to  $\leq 0.19$ : lower than ever before.



## AIMING FOR SAVINGS

the Evosta 3 model is supplied as standard with insulation shells which reduce the dispersion of thermal energy, ensuring further energy savings



# EVOJTA 3

## MECHANICAL STRENGTH

## ELECTRONICS EVOLUTION

### INVERTER

Evosta absorbs just the energy strictly necessary, ensuring significant cost savings.

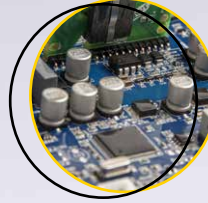

### USER INTERFACE

Intuitive interface providing immediate feedback for keeping the operating settings under control at all times.



### AIRVENT PLUG

Providing access to the shaft in case of seizure.



### UNIVERSAL CONNECTOR PLUG

Compatible with the connectors of our main competitors, meaning that it can be replaced without the need to rewire the electrical connection.



# FEATURES

## PUMP BODY

Cast iron pump body with cathaphoresis paint coating.



## MOTOR

Permanent-magnet synchronous motor.



## STEEL MOTOR CASING

AISI 304 stainless steel.



## INSULATION SHELLS

Supplied with an insulation kit reducing consistently the dispersion of thermal energy to guarantee further energy savings.



# EVOSTA 2

## NOW EVEN TO KEEP YOU COOLED



Increasingly complex systems, ever more advanced technologies and higher demand for better quality. In this scenario, DAB's Smart Factory offers all the answers to a more specialised market with the new Evosta 2 circulators. In the context of heating systems with solar panels for the recirculation of domestic hot water, and now also for cooling applications, the new Evosta 2 circulators represent the very latest evolution in terms of reliability and comfort, performance, low consumption and ease of use and maintenance.

Q max  
3,6 m<sup>3</sup>/h

H max  
6,9 m



EEI ≤ 0.18



## EVOSTA 2 S A N



Q max  
3,6 m<sup>3</sup>/h  
H max  
6,9 m



Q max  
0,6 m<sup>3</sup>/h  
H max  
1,1 m

Domestic hot water

## EVOSTA 2 S O L

Solar panel systems



Q max  
3,5 m<sup>3</sup>/h  
H max  
14,5 m

### WHY CHOOSE EVOSTA 2

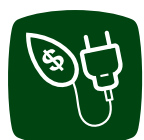

### APPLICATION



## OVERVIEW



### IPX5 PROTECTION

This certified degree of protection prevents the infiltration of water in the mechanics and, most importantly, in the electronics: faults are reduced to a minimum for absolute peace of mind.

### STEEL MOTOR CASING

Made with stainless steel grade AISI 304 ensuring maximum comfort and long life, even in the case of cooling applications.



### AIRVENT PLUG

Designed with front electronics and breather plug providing access to the shaft in case of seizure. Evosta 2: easier maintenance for greater peace of mind.

### USER INTERFACE

The new user interface with sequential button makes easier the setting..with a shells finger.



### MAXIMUM PERFORMANCE, MINIMUM CONSUMPTION

The energy performance of the new Evosta 2 has been improved with the new concepts of Smart energy and the use of an inverter, bringing the EEI index to  $\leq 0.18$ : lower than ever before.



EVOSTA 2

# EVOSTA 2

## MECHANICAL STRENGTH

## ELECTRONICS EVOLUTION

### INVERTER

Evosta absorbs only the energy that is strictly necessary, ensuring significant financial savings.

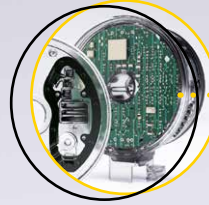

### USER INTERFACE

Intuitive interface providing immediate feedback for keeping the operating settings under control at all times.



### AIRVENT PLUG

Providing access to the shaft in case of seizure.



### CONNECTOR PLUG

Allows a simple and quick electrical connection, even in the most uncomfortable installation situations.





# FEATURES



## MOTOR

Permanent-magnet synchronous motor.

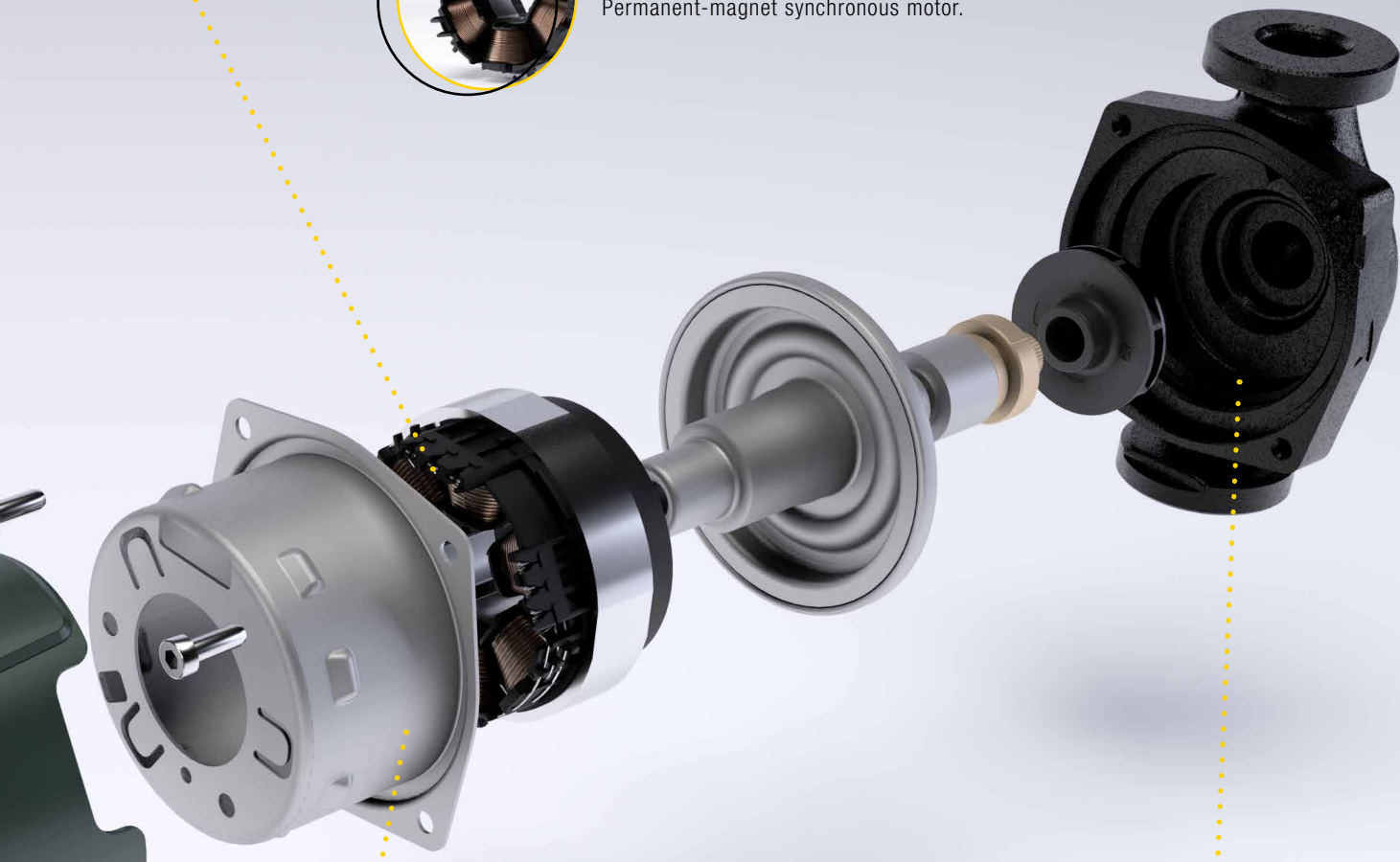

## PUMP BODY

EVOSTA 2 and SOL: Cast iron pump body with cathaphoresis paint coating.

EVOSTA 2 SAN bronze pump body.



## STEEL MOTOR CASING

AISI 304 stainless steel.

# MAGNETIC FILTERS

## UNPRECEDENTED EFFECTIVENESS



Nothing is more important than the quality of our work, the durability and efficiency of the systems, and the satisfaction of our customers. For this reason, DAB is entering in an agreement with Adey to offer a complete circulator-filter solution. Heating systems can be subject to dirt. Over 95% of this dirt consists of magnetite and iron oxide.

This is the main reason in percentage (70%) of failures, noise, leaks and inefficiencies. The D/MAG magnetic filters reduce impurities by 90%, increasing the life of the circulators and reducing both maintenance and energy costs.

Starting from today you can use the new Evosta circulators and the D/Mag filtering system as part of an integrated, reliable and safe solution simply by choosing the most suitable filter for the system:



### D.MAG COMPACT

**Operating range**  
up to 3 m<sup>3</sup>/h

**Pumped liquid temperature range**  
up to + 90°C

**Connections** 1"

**Working pressure** 6 bar

EVOSTA 2



EVOSTA 3



### D.MAG PRO TWIN

**Operating range**  
up to 6 m<sup>3</sup>/h

**Pumped liquid temperature range**  
up to + 95°C

**Connections** 1" 1/4 - 1" 1/2

**Working pressure** 6 bar

evoplus  
SMALL



# TECHNICAL DATA



	<b>EVOSTA 3</b>	<b>EVOSTA 2</b>	<b>EVOSTA 2 SAN</b>
<b>OPERATING RANGE:</b>	0,4 - 4,2 m <sup>3</sup> /h with head up to 8 metres	0,4 - 3,6 m <sup>3</sup> /h with head up to 6,9 metres	0,4 - 3,6 m <sup>3</sup> /h with head up to 6,9 metres
<b>PUMPED LIQUID TEMPERATURE RANGE:</b>	from -10 °C to +110°C	from -10 °C to +110°C	from -10 °C to +110°C
<b>WORKING PRESSURE:</b>	10 bar (1000 kPa)	10 bar (1000 kPa)	10 bar (1000 kPa)
<b>PROTECTION CLASS:</b>	IPX5	IPX5	IPX5
<b>INSULATION CLASS:</b>	F	F	F
<b>INSTALLATION:</b>	with horizontal motor shaft	with horizontal motor shaft	with horizontal motor shaft
<b>STANDARD POWER INPUT:</b>	single-phase 1x230 V~ 50/60 Hz	single-phase 1x230 V~ 50/60 Hz	single-phase 1x230 V~ 50/60 Hz
<b>PUMPED LIQUID:</b>	Clean, free of solids and mineral oils, non-viscous, chemically neutral, with properties similar to water (glycol max 30%)	Clean, free of solids and mineral oils, non-viscous, chemically neutral, with properties similar to water (glycol max 30%)	Clean, free of solids and mineral oils, non-viscous, chemically neutral, with properties similar to water (glycol max 30%)



	<b>EVOSTA 2 SAN</b>	<b>EVOSTA 2 SOL</b>
<b>OPERATING RANGE:</b>	0 - 0,6 m <sup>3</sup> /h with head up to 1,1 metres	0 - 3,5 m <sup>3</sup> /h with head up to 14,5 metres
<b>PUMPED LIQUID TEMPERATURE RANGE:</b>	from +2 °C to +75°C	from -10 °C to +110°C ( with peaks up to 130°C)
<b>WORKING PRESSURE:</b>	10 bar (1000 kPa)	10 bar (1000 kPa)
<b>PROTECTION CLASS:</b>	IP42	IPX5
<b>INSULATION CLASS:</b>	II	F
<b>INSTALLATION:</b>	with horizontal motor shaft	with horizontal motor shaft
<b>STANDARD POWER INPUT:</b>	single-phase 1x115-230 V~ 50/60 Hz	single-phase 1x230 V~ 50/60 Hz
<b>PUMPED LIQUID:</b>	Clean, free of solids and mineral oils, non-viscous, chemically neutral, with properties similar to water (glycol max 30%)	Clean, free of solids and mineral oils, non-viscous, chemically neutral, with properties similar to water (glycol max 30%)

**DAB PUMPS LTD.**

Unit 4 and 5, Stortford Hall Industrial Park,  
Dunmow Road,  
Bishops Stortford,  
Herts  
CM23 5GZ - UK  
salesuk@dwtgroup.com  
Tel. +44 1279 652 776  
Fax +44 1279 657 727

**DAB PUMPS IBERICA S.L.**

Calle Verano 18-20-22  
28850 - Torrejón de Ardoz - Madrid  
Spain  
Info.spain@dwtgroup.com  
Tel. +34 91 6569545  
Fax: +34 91 6569676

**DAB PUMPS SOUTH AFRICA PTY**

Twenty One industrial Estate,  
16 Purlin Street, Warehouse 4, Unit B  
Olifantsfontein - South - Africa  
info.sa@dwtgroup.com  
Tel. +27 12 361 3997  
Fax +27 12 361 3137

**DAB PUMPS B.V.**

Brusselstraat 150  
B-1702 Groot-Bijgaarden - Belgium  
info.belgium@dwtgroup.com  
Tel. +32 2 4668353  
Fax +32 2 4669218

**DAB PUMPS HUNGARY KFT.**

H-8800  
Nagykanizsa, Buda Ernő u.5  
Hungary  
Tel. +36 93501700

**DAB PUMPS (QINGDAO) CO. LTD.**

No.40 Kaihuo Road, Qingdao Economic & Technological  
Development Zone  
Qingdao City, Shandong Province - China  
PC: 266500  
sales.cn@dwtgroup.com  
Tel. +86 400 186 8280  
Fax +86 53286812210

**DAB PUMPS POLAND Sp. z o.o.**

Mokotów Marynarska  
ul. Postępu 15C  
02-676 Warszawa - Poland  
polska@dabpumps.com.pl  
Tel. +48 223 816 085

**DAB PUMPS B.V.**

Albert Einsteinweg, 4  
5151 DL Drunen - Nederland  
info.netherlands@dwtgroup.com  
Tel. +31 416 387280  
Fax +31 416 387299

**OOO DAB PUMPS**

Novgorodskaya str. 1, block G  
office 308, 127247, Moscow - Russia  
info.russia@dwtgroup.com  
Tel. +7 495 122 0035  
Fax +7 495 122 0036

**DAB PUMPS DE MÉXICO, S.A. DE C.V.**

Av Amsterdam 101 Local 4  
Col. Hipódromo Condesa,  
Del. Cuauhtémoc CP 06170  
Ciudad de México  
Tel. +52 55 6719 0493

**DAB PUMPEN DEUTSCHLAND GmbH**

Tackweg 11  
D - 47918 Tönisvorst - Germany  
info.germany@dwtgroup.com  
Tel. +49 2151 82136-0  
Fax +49 2151 82136-36

**DAB PUMPS INC.**

3226 Benchmark Drive  
Ladson, SC 29456 - USA  
info.usa@dwtgroup.com  
Tel. 1- 843-797-5002  
Fax 1-843-797-3366

**DAB PUMPS OCEANIA PTY LTD**

426 South Gippsland Hwy,  
Dandenong South VIC 3175 - Australia  
info.oceania@dwtgroup.com  
Tel. +61 1300 373 677